

New!

**VAF**

INSTRUMENTS



# ProFlow

Sliding Vane Meters DN 15-50 (1/2" - 2")

**142**

Product Bulletin

[WWW.VAF.NL](http://WWW.VAF.NL)

**TO BE  
REALLY  
SURE**

# Introduction

VAF Instruments ProFlow positive displacement sliding vane type liquid flowmeters are used in continuous metering applications of oil-like liquids, especially for accurate measurement of fuel oil consumption.

ProFlow flowmeters have a simple, rugged design. With only few almost frictionless moving internal parts there is hardly any wear in the flowmeter which safeguards a typical long lasting lifetime. ProFlow meters have no mechanical seals saving you from regular maintenance and possible leakage of process liquids into the environment. The flowmeter is driven by the process liquid which makes it suitable for distant locations without power supply.

The high accuracy of the flowmeter (down to 0.2% and repeatability 0.05%) is not influenced by process pressure or temperature, mechanical pipe strain or liquid turbulence and therefore straight inlet and outlet pipe pieces are not required.

## Experience in flow measurement

In 1938 VAF Instruments started as a manufacturer of petrol delivery pumps. The flowmeters made by VAF for this pump already had to have the highest accuracy and had to meet the demands of the board of weights and measures. Innovation and research over the past 75 years helped VAF to make new types of flowmeters bearing in mind customer requirements and the need for accurate flow measurement. VAF Instruments flowmeters are available in sizes from 8 mm up to 300 mm (1 l/hr up to 960 m<sup>3</sup>/hr). ProFlow flowmeters cover the middle part of this range.

## Available ProFlow flowmeters

ProFlow flowmeters are available in connection sizes from 15 mm up to 50 mm representing maximum flow ranges from 50 l/min up to 500 l/min. For registration of the measured amount of liquid VAF ProFlow meters can be fitted with digital totalisers with or without pulse transmitter.

## Liquids

ProFlow flowmeters are specially developed for measurement of all kinds of hydrocarbon liquids, in particular medium and heavy fuel oils for combustion engines, lubricating oils and many other oil-like liquids.

## Special versions

This brochure comprises only VAF Instruments standard delivery program. Special flowmeter executions can be offered as tailor-made solutions.

Consult VAF Instruments for further information.

# Principle of operation

ProFlow flowmeters operate on the sliding vane principle. The meter consists of a specially shaped housing in which a rotor can rotate freely. Two pairs of vanes are placed into four slots in the rotor. Each pair is positioned by a rod and can move in and out of the rotor. The radial vane movement is guided by the special inner shape of the housing. This patented construction provides a constant seal between the inlet and the outlet of the meter.

The incoming liquid forces the rotor to rotate. An internal magnet transmits the rotor rotations from the measuring chamber to a built-on electronic counter (standard). An electric pulse output can be installed as option for remote totalising or flow data processing.

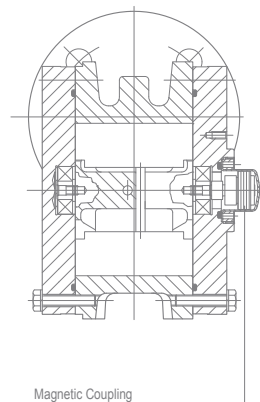
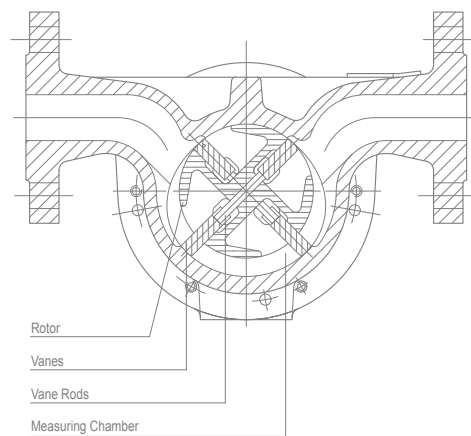

Fig. 1 Sectional view

# Features & benefits

Features	Benefits
High capacity and rangeability	One meter for a wide range of flows
	Superior turn down ratio
	Lower investment
High accuracy (down to $\pm 0.2\%$ )	Exact registration of transferred amount of liquid
	No loss of valuable raw material
Design simplicity	Easy to service
	No complex replacement parts
	Low operation cost
Accuracy not degraded by: process pressure / process temperature / liquid viscosity / liquid conductivity / pipe strain / flow pattern (turbulence)	Easy to operate because no need for external settings saving time in operation and training
	One single meter model is suitable for different liquids resulting in a lower investment
	No straight pipe required before or behind meter thus and less space required
Compact design	Easy to integrate in compact systems
	Space saving
Constructed to CE standards	No special adjustments necessary
ISO 9001 registered company	Assured product quality
Few internal parts	Less wear
	Long lifetime
	Low operation cost
Measurement driven by liquid	No auxillary power needed
	Low pressure drop
	Suitable for many remote locations



# Technical specification

## Typical calibration curves

VAF Instruments flowmeters perform liquid measurement with the highest accuracy. This graph shows typical calibration curves for liquids with different viscosities. Consult the factory for other values.

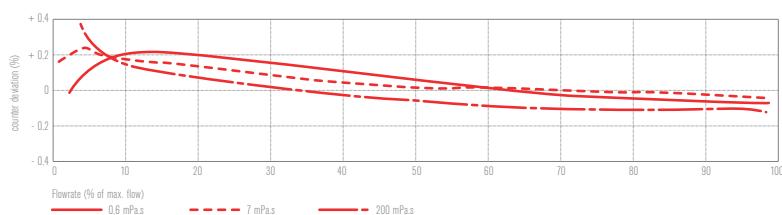

Basic model number	J5015E	J5023E	J5025E	J5040E	J5050E
Connection size, DN [mm]	15 mm (1/2")	25 mm (1")	25 mm (1")	40 mm (1.5")	50 mm (2")
Capacity [l/min]	see graphs				
Maximum, 8 hrs/day discontinuous	50	50	160	250	500
Maximum, continuous	37.5	37.5	120	187.5	375
Displaced volume per revolution [litre]	0.025	0.025	0.167	0.167	0.40
Measuring accuracy					
range 1:10 <sup>1</sup>	0.2 %				
range 1:20 <sup>2</sup>	0.3 %				
Repeatability	better than $\pm 0.05$ %				
Required starting pressure [kPa (bar)]	3 (0.03)				
Materials body, flanges, covers and rotor	ductile iron				
Vanes	carbon				
O-rings	viton A				
Body pressure rating [kPa (bar)]	4000 (40)		2500 (25)		
Available flanges					
DIN PN (bar) raised face or with groove acc. DIN 2512N	6, 10, 16, 25, 40		6, 10, 16, 25		
ANSI RF	150, 300		150, 300		
JIS K	5, 10, 16, 20		5, 10, 16, 20		
Liquid temperature range standard	-10°C to 125°C				-10°C to 125°C
On application	-10°C to 180°C				-10°C to 160°C
Built-on counter	7 digit resettable totaliser				
smallest readout unit	0.1 litre, 0.001 m <sup>3</sup>		0.001 m <sup>3</sup>	0.001 m <sup>3</sup>	
Optional pulse transmitter	1 scalable pulse output				
Pulse type	open collector NPN				
Weight without counter [Kg]	5	7	12	14	22

Notes: <sup>1</sup> Standard factory calibration. <sup>2</sup> Calibration on request.

### Flow ranges

To select the appropriate meter size for your process the graphs must be used. The data in these graphs only refer to standard flowmeters used on Newtonian liquids. Consult VAF Instruments for viscosities higher than shown in the graphs. Lower minimum capacities are possible dependent on liquid viscosity and required measuring accuracy.

### Flowrate - pressure drop viscosity relation

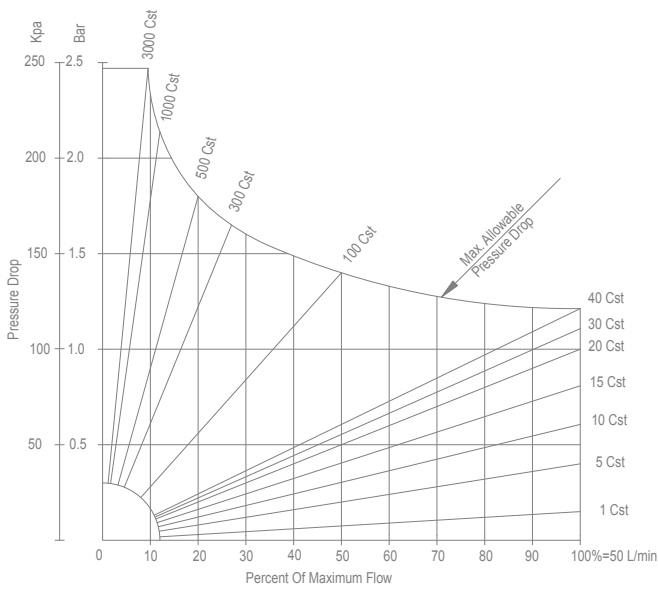

Models J5015E / J5023E: 100% = 50 l/min

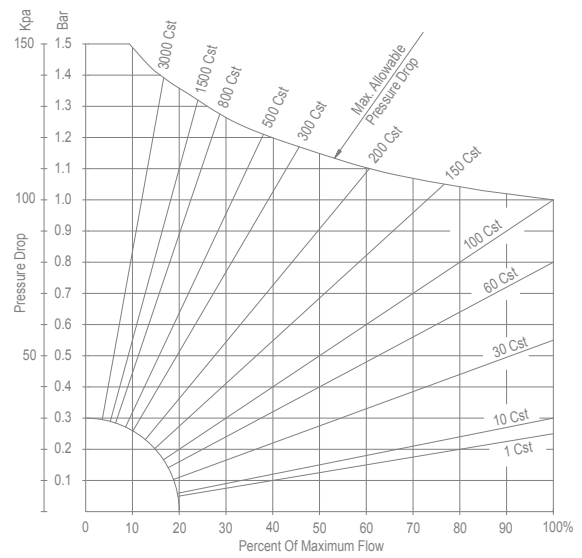

Model J5025E: 100% = 160 l/min

Model J5040E: 100% = 250 l/min

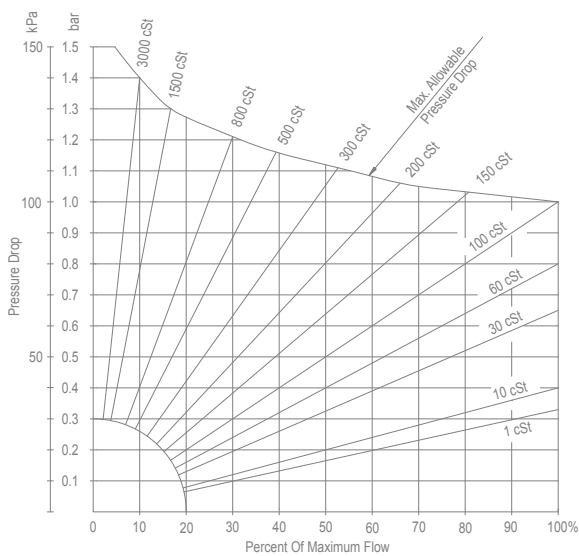

Model J5050E: 100% = 500 l/min



---

## Options and accessories

### Liquid filter

The process liquid must be clean and free from air, gas or dirt. Solid particles may cause excessive wear. It is recommended to install a liquid filter with a suitable mesh width. If necessary also install an air vent.

### Electronic signal processing instrumentation

A complete range of electronic signal processing instrumentation is available.

### Built-on Totaliser

ProFlow flowmeters are equipped with a built-on totaliser. See tables for counter reading units and combinations of totaliser and pulse output.

Consult VAF Instruments for special counters and pulse transmitters not mentioned in this brochure.



Fig. 2 E-counter

---

## Applications

- Fuel consumption measurement of internal combustion engines and oil burners;
- Injection of oils;
- Measurement of fluid movement in hydraulic systems;
- Accurate measurement of viscous fluids at low flow rates.

# Dimensions

Dimensions apply to flowmeters with DIN flanges.

Dimensions of flowmeters with other pressure ratings are available on application.

All dimensions are in millimeters.

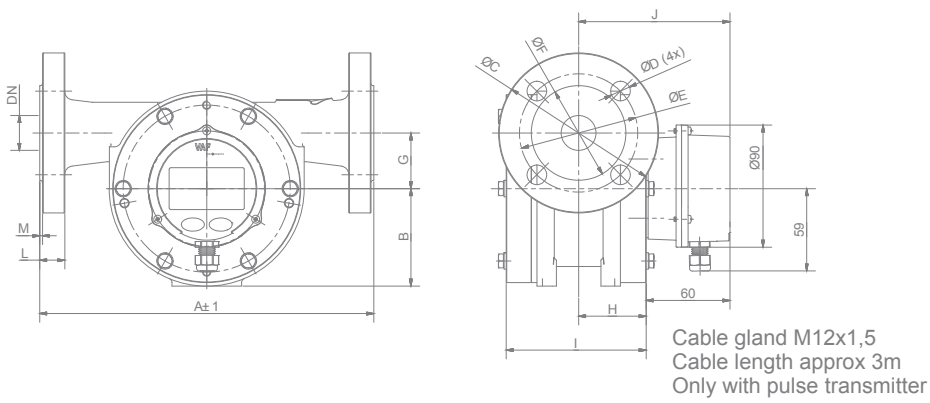

Meter type	Connection size	A	B	G	H	I	J
J5015E	DN 15 mm (1/2")	180	50	24	33	70	93
J5023E	DN 25 mm (1")	220	50	24	33	70	93
J5025E	DN 25 mm (1")	240	70	40	51	101	110
J5040E	DN 40 mm (1.5")	240	70	40	51	101	110
J5050E	DN 50 mm (2")	260	85	50	72	143	132

### Quotation & ordering information

For proper selection of the suitable ProFlow meter the following data should be determined:

**Liquid data:**

1. **Process liquid** (trade name or chemical composition):
2. **Flowrate** [l/min] minimum: \_\_\_\_\_ continuous: \_\_\_\_\_ maximum: \_\_\_\_\_
3. **Operating pressure range** [bar]: \_\_\_\_\_ allowable pressure drop [bar]: \_\_\_\_\_
4. **Operating temperature range** [°C] process liquid: \_\_\_\_\_ ambient: \_\_\_\_\_
5. **Specific gravity at operating conditions:** \_\_\_\_\_ viscosity: \_\_\_\_\_

**Flowmeter data:**

6. **Basic model number:** \_\_\_\_\_
7. **Diameter liquid piping:** \_\_\_\_\_
8. **Connection flanges:**     DIN PN [bar]             ANSI RF [lbs]             JIS [K]
9. **Direction to flow:**     left to right             right to left             top to bottom             bottom to top
10. **Optional pulse transmitter** (see technical specification table):  
 required             not required  
       number of pulse/litre: \_\_\_\_\_
11. **Liquid filter:**            required            not required
12. **Special certification:**     material certificate according EN 10204 3.1  
        standard factory accuracy calibration certificate
13. **Other options and accessories:** \_\_\_\_\_

All copyrights reserved | Publ. No. PB-142-66-0414 | Supersedes Publ. No. PB-142-66-0013

Name: \_\_\_\_\_

Place and date: \_\_\_\_\_

For further information see relevant Product Bulletins or [www.vaf.nl](http://www.vaf.nl)

Represented by

**VAF Instruments B.V.**

Vierlinghstraat 24, 3316 EL Dordrecht, The Netherlands  
 P.O. Box 40, 3300 AA Dordrecht, The Netherlands  
 T +31 (0) 78 618 3100, F +31 (0) 78 617 7068  
[sales@vaf.nl](mailto:sales@vaf.nl), [www.vaf.nl](http://www.vaf.nl)

Specifications subject to change without notice.

Agents and distributors in more than 50 countries.

