

**FUEL SAVING POTENTIALS VIA
MEASURING PROPELLER THRUST AND
HULL RESISTANCE AT FULL SCALE:
EXPERIENCE WITH SHIPS IN SERVICE**

A scientific paper by VAF Instruments Research & Development
Erik van Ballegooijen, Technical Consultant Hydrodynamics
Tiberiu Muntean, R&D Engineer

Published and presented at Hull Performance & Insight Conference 2016
(HULLPIC2016), Castello di Pavone / Italy 13-15 April 2016

WWW.VAF.NL

**TO BE
REALLY
SURE**

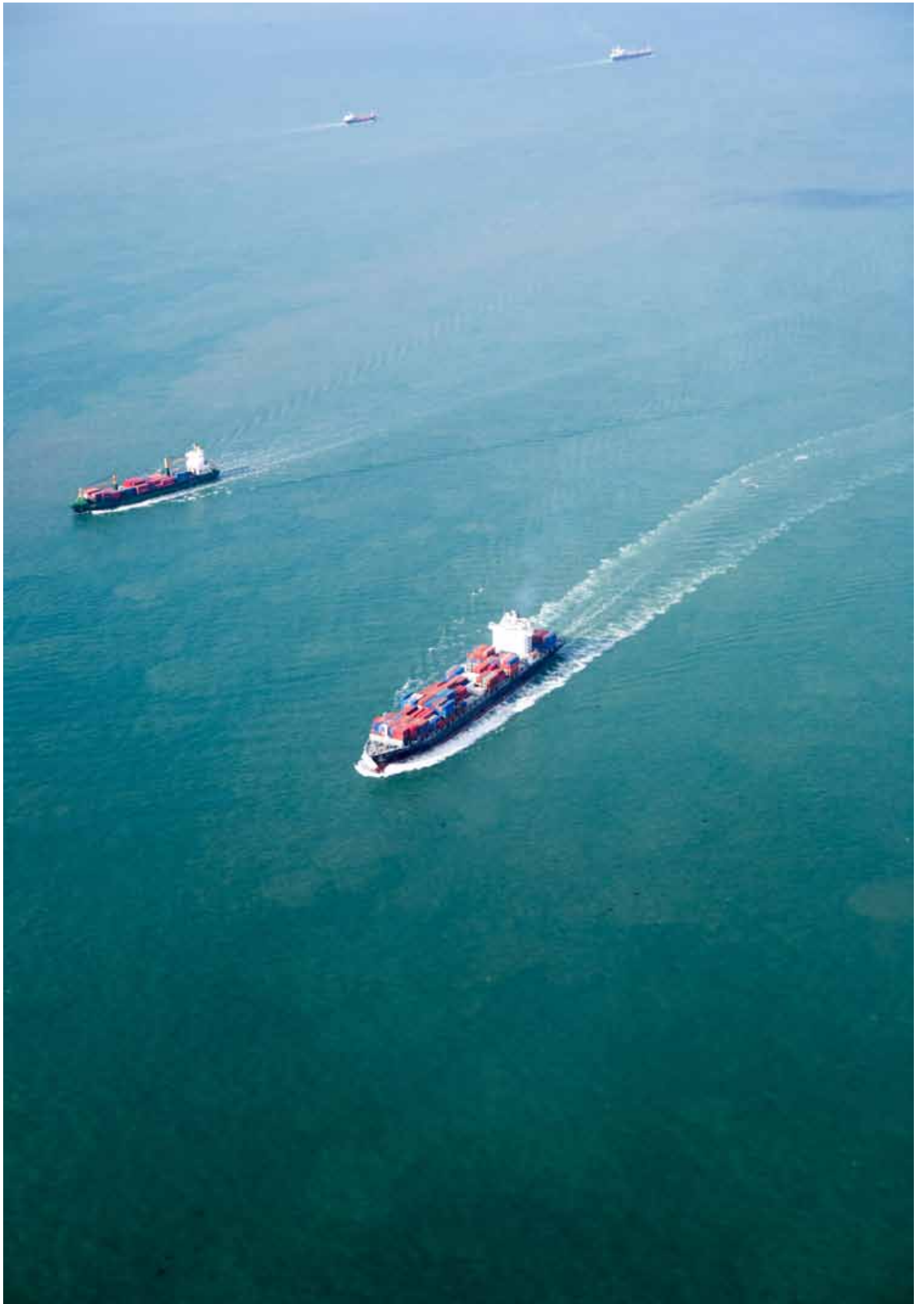

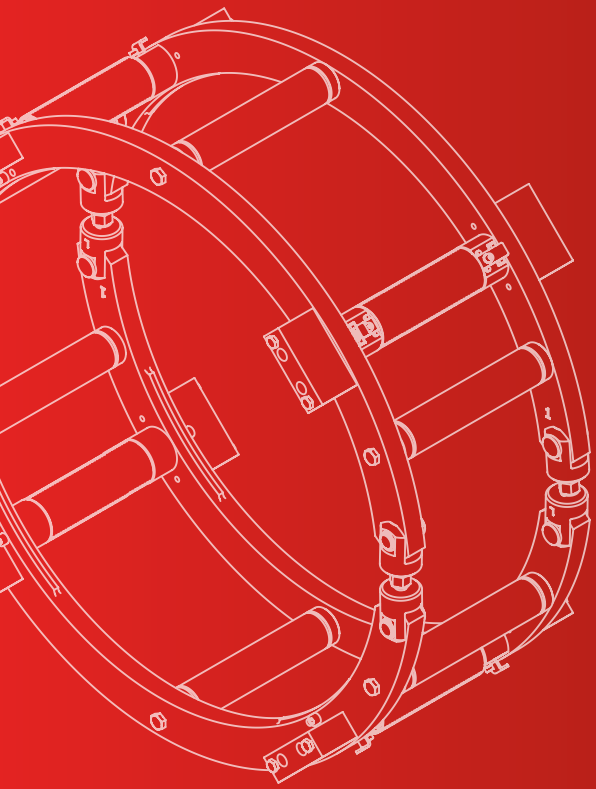

Abstract

This paper presents the possibilities offered by the full scale measurement of propeller thrust (and torque), to identify fuel saving potentials and emission reductions. Via full scale measurements of propeller thrust and torque, in relation to other parameters like ship speed, the change in propeller efficiency and the hull resistance can separately be determined over time. This for instance due to propeller or hull fouling, propeller damages and hull coatings. In addition an example will be shown of measurement results, and the possibilities of the propeller thrust and torque measurements, on a +13000 TEU container vessel in service.

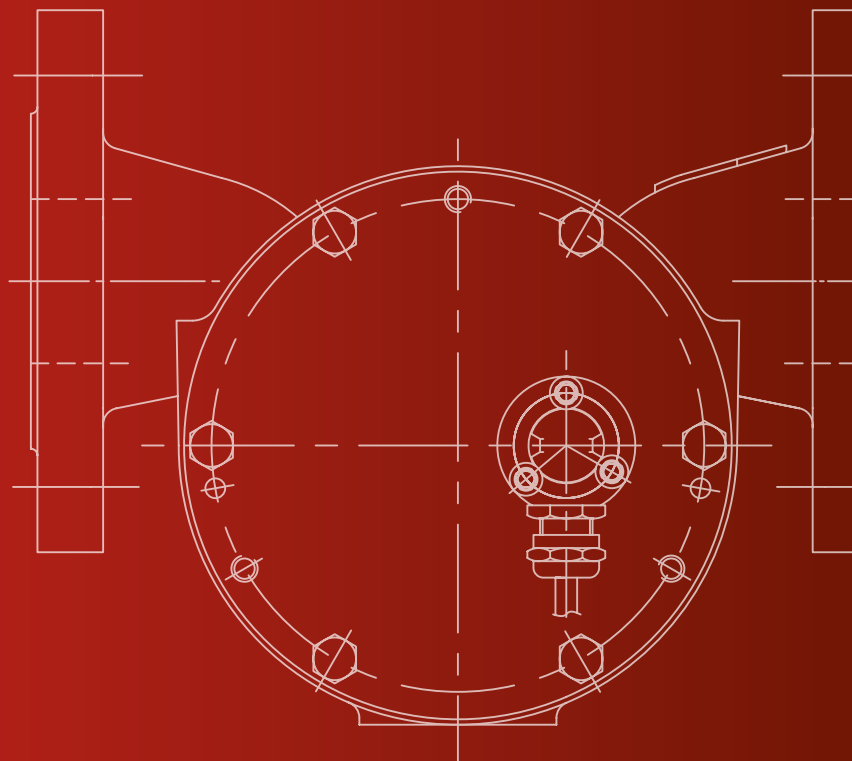

1. INTRODUCTION

In general there is a large interest in the maritime world for ship propulsion efficiency. This has several reasons related to either cost savings, legislation, and/or environmental concern. An example is the focus on fuel consumption which has a direct cost relation, but has also a link to the environment when looking at green house gas emissions. In order to be able to improve on the fuel consumption and green house gas emissions, these need to be measured before any improvement actions can be verified. When looking at ship propulsion, this means to measure and quantify the present status and possible changes over time of for instance the propeller efficiency, and the total ship resistance due to propeller and hull fouling or damages.

This paper describes the way to measure the propeller efficiency over time, separate from the hull resistance, via measuring the propeller thrust, next to the common used propeller torque. If the propeller thrust is measured, the actual propeller condition can be separated from the ships hull condition. This is important for several reasons:

- a. To determine the proper timing for a hull cleaning based on the actual hull resistance without the propeller condition taken into account.
- b. To determine the actual effect of a newly applied hull coating on the ships resistance.
- c. To determine the proper timing for a propeller cleaning (this might differ from the hull cleaning timing due to measured difference in fouling condition of hull and propeller).
- d. To determine possible propeller damages, which result in a propeller performance decrease.
- e. To determine the optimal propeller efficiency conditions at several ship operational conditions (as an example to determine the effect of variable rpm versus constant rpm on propeller efficiency for a controllable pitch propeller).
- f. To determine the effect of energy saving devices (like a BCF or WED) or propeller or hull modifications (like for instance a new bulbous bow design).

VAF Instruments (the Netherlands), a well known supplier of measurement systems for the maritime market, developed the TT-Sense® thrust and torque sensor. The sensor, which is already on the market for more than three years, has been used by VAF Instruments R&D department to quantify vessel performance and to track the changes in vessel performance over time. Experience is gained until now on many types of vessels from small cargo vessels towards 14000 TEU container vessels, as well as on navy vessel shaft lines.

Once the propeller thrust and torque are known, together with several other to be measured parameters, the condition of the propeller and the ships hull can be determined separately. In the next chapters a more detailed description is given on these type of measurements, and an example is shown of the measurement results achieved on a +13000 TEU container vessel in service.

2. MEASUREMENT LAY OUT

In order to determine via measurements the propeller and ships hull condition, several parameters need to be taken into account and measured. In the next paragraph a general overview of these various parameters is shown. Special attention is paid to the propeller thrust measurement via the TT-Sense® sensor.

2.1. Parameters to be measured

In order to determine via measurements the propeller and ships hull condition, several parameters need to be taken into account and measured. A typical list of to be measured parameters consists of:

- Propeller thrust
- Propeller torque
- Propeller RPM
- Speedlog
- GPS location
- Ships draft
- Seastate
- Wind

The majority of these parameters are already measured and available on board of a ship via dedicated sensors, and or log reports. Propeller power, via torque and RPM, is nowadays a rather common measurement on board of a ship. But in

order to be able to separate the propeller performance from the ships hull performance, also the propeller thrust needs to be measured. This asks for an additional propeller thrust sensor. The TT-Sense® propeller thrust and torque sensor used in this investigation is discussed in the next paragraph.

In order to determine a trend over time of the change in propeller and ships hull performance, the above parameters are advised to be monitored over a longer time period of typically 1/2 to 1 year. Additional it must be noted that the various parameters need to be monitored at their characteristic frequencies. Ships draft for instance remains constant over a longer time period compared to for instance the propeller thrust. As such the measurement frequency is different for the various parameters.

In the used measurement setup all these various signals are logged digitally on a central computer on board of the ship. This collected data is then send to shore via satellite connection on a regular daily basis. This allows for a daily follow up of the propeller and ships hull condition.

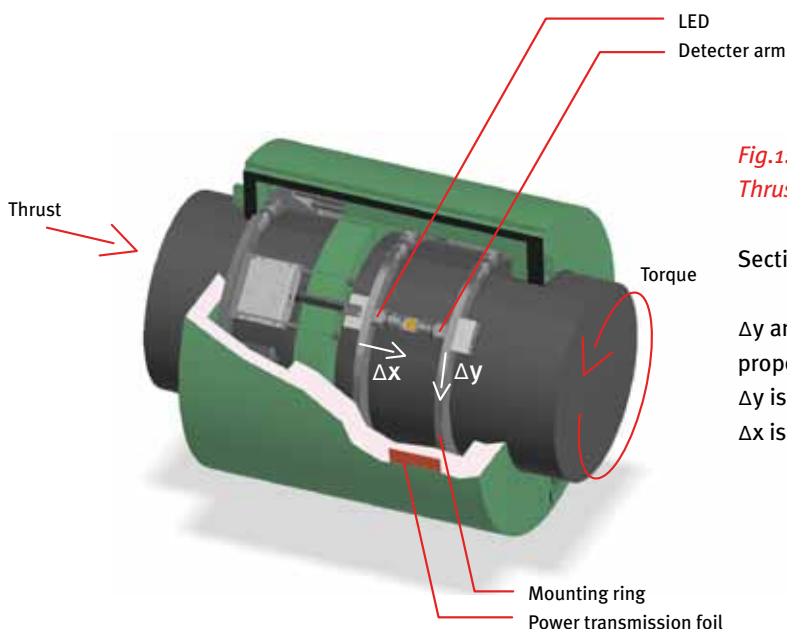

Fig.1: General working principle of the TT-Sense® Thrust and Torque sensor around propeller shaft.

Sectional view

Δy and Δx are small movements of the propeller shaft surface due to strain. Δy is the movement in torque direction and Δx is the movement in thrust direction.

2.2. Thrust and Torque measurement sensor

In view of the propeller and ships hull performance measurements, the propeller thrust is of special interest, as this measurement allows for a split in performance between propeller and hull. In the measurements discussed in this paper, use is made of the VAF Instruments TT-Sense® propeller thrust and torque measuring system. This TT-Sense® sensor can be mounted on propeller shafts between the propeller and the thrust bearing. When a shaft is subject to thrust and torque this results in a small compression and torsion of the shaft. The working principle of the TT-Sense® is based on measuring this shaft compression and torsion over a shaft length of typical 200 [mm]. This relative long measuring area of the shaft, compared to for instance strain gages, highly increases the measurement

accuracy. LED's and extremely accurate optical sensors detect the small displacements over the shaft length, in both axial and tangential directions, corresponding to the compression (thrust) and torsion (torque) of the propeller shaft. The used optical measurement principle allows for an independent measurement of both the thrust and the torque. In Figure 1 the general working principle of the TT-Sense® thrust and torque sensor is shown. The measured values of thrust and torque are transferred continuously from the rotating shaft to the stator part through wireless data connection with a 100 Hz transfer rate. Power transmission from the stator to the rotating shaft is performed by means of induction. The stator part consists of a power transmission coil, a data signal receiver and a control box equipped with digital or analogue output connections.

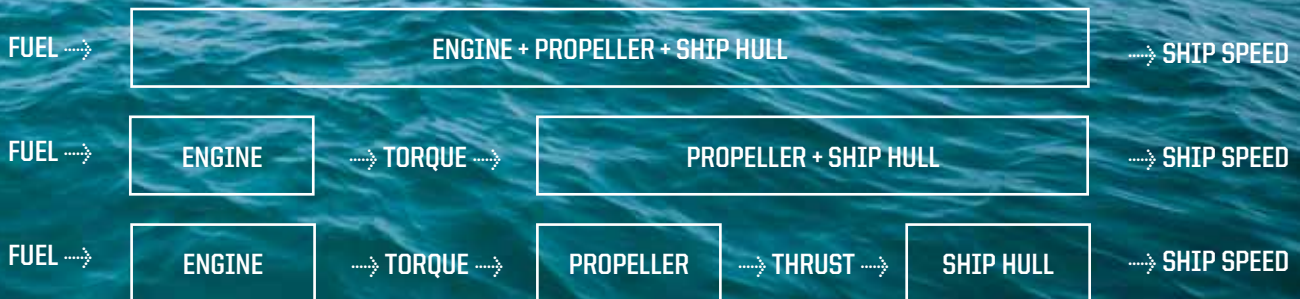
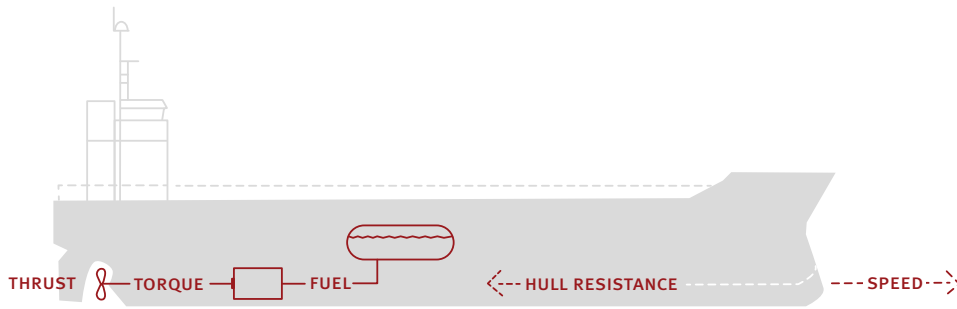

Energy conversions & efficiencies

Only by measuring propeller thrust you are able to separate the propeller efficiency from the hull resistance

3. THEORETICAL APPROACH FOR PROPELLER AND SHIPS HULL PERFORMANCE MEASUREMENT

When looking at the performance of the propeller and ships hull, this can be done via two ways. The first route is via the common used power / torque measurement. This provides only performance indications of the combined propeller and hull system, but not on each of them individual.

The second route is via propeller thrust measurements. When applying additional propeller thrust measurements the performance evaluation of propeller and ships hull can be split. In the next paragraphs these two routes are explained in more detail.

3.1. Performance evaluation based on torque measurements

When measuring power / torque as input, and the ship speed as output (Figure 2.), there can be derived a certain “efficiency” which is the conversion of propulsion power into ship speed. This is the well known speed – power relation of a ship, which can change over time due to for instance fouling of propeller or hull.

Route 1:

Torque \rightarrow **Propeller + Ship Hull** \rightarrow Ship speed

Fig.2: Performance measuring via power / torque towards ship speed

Drawback of measuring the ships performance via only power / torque is that there can be made no distinction between change in propeller performance and hull performance. As such, when a deterioration in the speed – power performance of a ship is noticed, based on a power / torque measurement, it cannot be determined if this is caused by for instance either a propeller fouling or damage, or an increased hull fouling, or a combination of both. This hampers the decision making on taking the proper action for performance improvement, i.e. should there be taken actions on the hull, or on the propeller, or both.

3.2. Performance evaluation based on thrust measurements

When taking also propeller thrust into account, as represented in Figure 3, the route power / torque \rightarrow propeller thrust \rightarrow ship speed, provides two kinds of efficiencies or conversions. For the propeller this is the well known propeller efficiency, where input torque is converted into thrust at a certain RPM and water inflow velocity. For the ships hull the efficiency might be seen as the transformation of thrust towards ship speed, where the “efficiency” of this transformation is related to the hull resistance.

Route 2:

Torque \rightarrow **Propeller** \rightarrow Thrust \rightarrow **Ship Hull** \rightarrow Ship speed

Fig.3: Performance measuring via torque and thrust towards ship speed

The advantage of measuring in addition the propeller thrust is the possibility to distinguish between propeller and hull performance. By doing so an increase in fuel consumption can be directly related to either the propeller, or the ships hull. This in return allows to direct the proper corrective actions to the component which actually shows the performance drop.

As will be shown in the next chapter, in which full scale measurements are presented, the propeller performance deterioration plays, next to the hull, an important role in the total ship performance.

4. PROPELLER AND HULL PERFORMANCE MEASUREMENTS ON A +13000 TEU CONTAINER VESSEL IN SERVICE

The previously described routes for total ship propulsion performance evaluation, are tested on board of several ships, making use of the VAF Instruments TT-Sense® thrust and torque sensor. In this chapter the results of one of these ships are discussed in more detail. The ship is a +13000 TEU container vessel with a fixed pitch propeller, operating on a fixed schedule between Asian and European container terminals. On this particular container vessel, the various parameters as described in paragraph 2.1 have been measured over approximately 1.5 years. As both the propeller torque and the propeller thrust have been measured, both performance evaluation methods as described in paragraph 3.1 and 3.2 have been evaluated for this ship. In the next paragraphs the various results are presented and discussed.

4.1 Performance over time based on power measurements

The first performance evaluation for this particular container vessel is based on the propeller torque measurements. This is the conventional way of analysing the total ships performance, as described in paragraph 3.1, in which no distinction between the propeller and hull performance is made.

As a first indication of the quality of the measurements, the measured speed - power curve of the vessel is shown in Figure 4. It must be noted that for this speed - power curve it is important to use the actual speed through water (STW) instead of the speed over ground. This as there might be relevant difference between the speed over ground and the speed through water due to water current. And as the actual ships resistance depends on the actual speed of the vessel through the water, the measured speed through water is to be used. It must also be noted that in a separate study the quality of the speed through water measurement of the actual speedlog of this vessel, turned out to be of high accuracy. This very much improves the accuracy of the measured performance of the ship over time as will be shown further on.

In addition during the measurement period of 1.5 years, although this particular container vessel is sailing identical routes, there are other important parameters which vary over time. These varying parameters relate to the ships draft, seastate, and wind, but also temporarily acceleration and deceleration of the vessel. For all these parameters a proper filtering is applied in order to remain with the relevant measuring points which at the end serve for comparison.

As can be seen from the measured speed – power curve in Figure 4, during the measurement period of 1.5 years there is a good correlation with model test predictions. Shown variations in the measured values are expected to be related to the actual draft differences compared to the model test draft, the influence of minor rudder steering, the actual present (low because filtered) seastate and wind, but also due to an increase in fouling over time, which all add additional resistance.

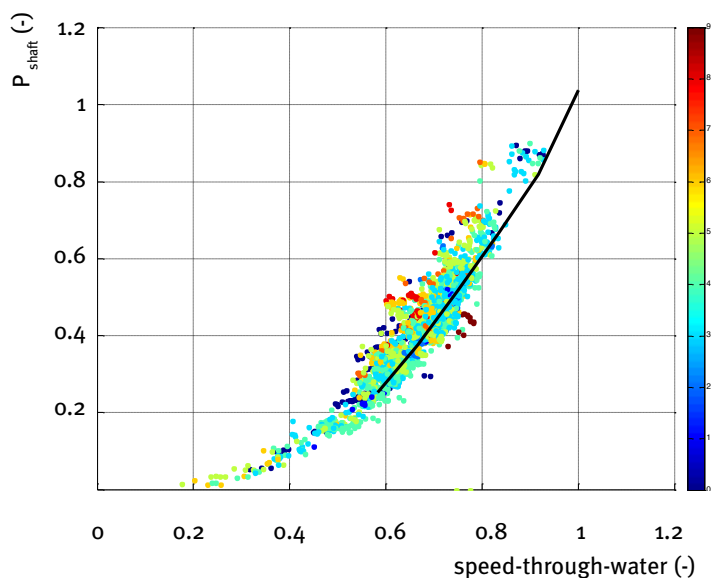

Fig.4: Speed (through water) – power curve for +13000 TEU container vessel over a 1.5 year period.

The next step is to investigate how the power needed at a certain ship speed is changing over time. This in order to see if the total ship performance (propeller + hull) is deteriorating. For this the change in total “ship resistance” coefficient δ is calculated as $\delta = P_{\text{shaft}} / STW^\alpha$ in which the power factor α is determined based on the actual measurements in Figure 4.

In this way the total “ship resistance” coefficient δ can be calculated for every measurement point, and can be plotted over time. The outcome is shown in Figure 5, where at the start of the measurements the measured value is set to 100%. The remaining measurement values are all calculated relative to the first measured value in order to be able to show the relative change in total “ship resistance” coefficient over time.

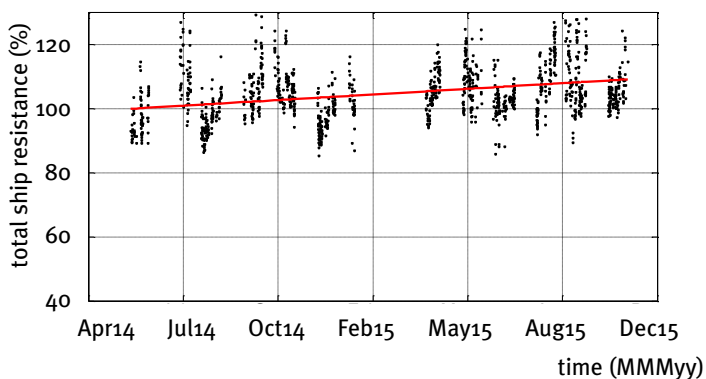

Fig.5: Total “ship resistance” coefficient δ over time, increase is 9.2% (equals 6.4% per year).

From this figure the following conclusions can be drawn. At first it is clearly visible that the calculated total “ship resistance” coefficient has a spread. This might be explained by the earlier described variations in measured power at a certain speed through water as seen in Figure 4. But when calculating the linear regression line over time through all the individual points, it is clearly visible that the total “ship resistance” coefficient is increasing over time. For the time frame of the measurements, the total “ship resistance” increases by +9.2%. This equals to an increase of +6.4% per year.

4.2 Performance over time based on thrust measurements

The second performance evaluation for this particular container vessel is based on the propeller thrust measurements, as described in paragraph 3.2. Here a clear distinction between the propeller and hull performance can be made. In the next paragraphs the separate outcome of the measured propeller performance (efficiency), and hull resistance will be shown and discussed.

4.2.1 Propeller open water curve measured at full scale

As both propeller thrust and torque are measured, together with measured speed through water and propeller RPM, it is possible to calculate for each individual measurement point the propeller open water characteristics (J , K_t , $10K_q$). Herein the J -value is determined with the wake fraction based on propulsion model tests, performed for this particular container vessel.

The +13000 TEU container vessel discussed here is equipped with a fixed pitch propeller (FPP). For this specific FPP propeller design, the propeller open water curves are determined from open water tests performed at a model test institute with the exact (scaled) geometry of the actual full scale FPP. The model scale open water curves are then the basis for the prediction of the full scale propeller performance by the model test institute.

In Figure 6 the full scale propeller open water curve from model tests is shown, together with the actual measurement points via the thrust and torque measurements performed via the TT-Sense® sensor on board of the +13000 TEU container vessel. As can be seen in this Figure, the model test predictions are fairly good in line with the actual measurement points. This provides an important indication that the total set of measured parameters on board of the ship are accurate and stable in time.

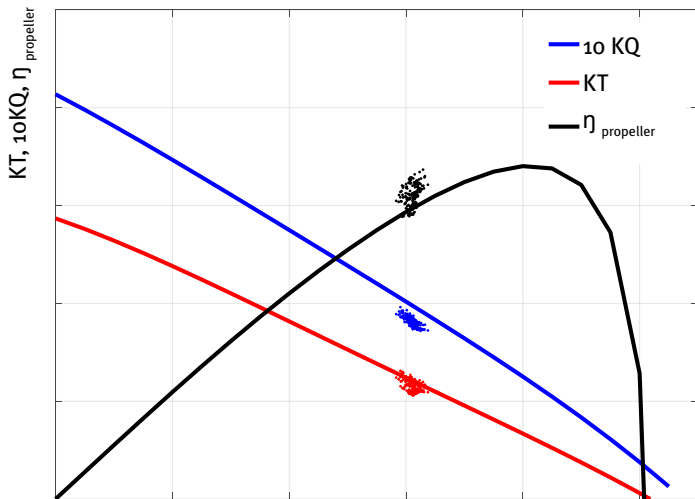

Fig.6: Propeller open water curves: measurements at full scale with TT-Sense® (dots), versus full scale predictions based on model tests (lines).

4.2.2 Propeller efficiency over time

Since it is now possible to measure the individual propeller performance (efficiency), the next step is to evaluate this propeller performance over time. This to determine any possible propeller performance deterioration. For this, the propeller efficiency measurement points are plotted over time. The outcome is shown in Figure 7, where at the start of the measurements the measured absolute propeller efficiency value is set to 100%. The remaining measurement values are all calculated relative to the first measured value in order to be able to show the relative change in total propeller efficiency over time.

As can be seen in Figure 7, there is a spread of the individual measured propeller performance (efficiency) points. The spread can be related to measurement accuracy of the various parameters influencing the propeller efficiency (like speed through water, thrust, torque, RPM), but also the actual propeller condition like the propeller surface fouling or damages.

When calculating the linear regression line over time through all the individual points, it is clearly visible that the propeller performance (efficiency) is decreasing over time. For the time frame of the measurements, the propeller efficiency decreases by 3.7%. This equals to a decrease of 2.6% per year.

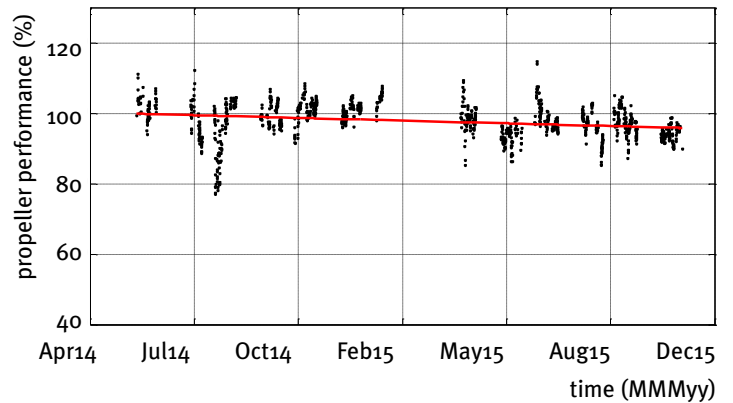

Fig.7: Propeller performance over time, decrease is 3.7% (equals 2.6% per year).



Ship voyages during measurement

4.2.3 Hull performance over time

Next to the propeller efficiency, also the hull resistance can be determined based on the propeller thrust measurements. The hull resistance R at a certain speed through water is proportional to the propeller thrust T as in $R = T(1-t)$. For ease of comparison, the thrust deduction factor t is taken constant for all relevant free sailing conditions, which is supported by model test results.

The measured propeller thrust is plotted against the measured speed through water in Figure 8. This graph indicates a fairly good correlation between the full scale measurements and the model test predictions. Shown variations in the measured thrust values are among others expected to be related to the actual draft differences compared to the model test draft, the influence of minor rudder steering, and the actual present (low because filtered) seastate and wind, which still add additional resistance. Additionally, the fouling of the hull is also playing a role during this time period.

It is commonly accepted that the total resistance is a function of vessel speed through water, as in $R = \frac{1}{2} \rho C_d A STW^2$ with ρ the water density, C_d the drag coefficient, and A the area of cross section. Since some of these parameters are sometimes difficult to reliably estimate (i.e., the C_d), a more generic modelling of the resistance is used, as in $R = C STW^\beta$ for which the parameter β is determined based on the measurements as shown in Figure 8. Herein C is the hull resistance coefficient, which is an indication for the performance of the hull. The hull resistance coefficient C can be rewritten as:

$$C = T(1-t) / STW^\beta$$

Fig.8: Thrust - speed (through water) curve for +13000 TEU container vessel over 1.5 year period

Next step is to follow the changes in the hull resistance coefficient C over time. This to determine any possible hull performance deterioration due to for instance hull fouling or hull coating deterioration. The hull resistance coefficients are plotted over time and the outcome is shown in Figure 9. At the start of the measurements the measured absolute hull resistance coefficient value is set to 100%.

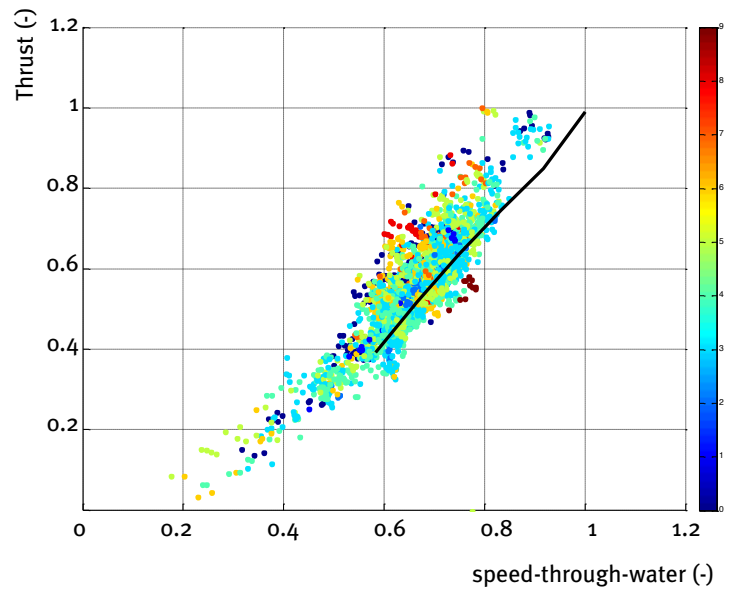
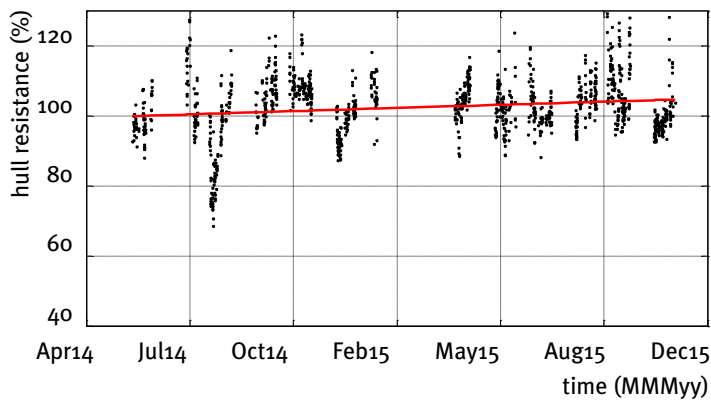

Fig.9: Hull resistance coefficient over time, total increase is 5.2%, (equals 3.6% per year)

From figure 9 the following conclusions can be drawn. At first it is clearly visible that the calculated hull resistance coefficient has a spread. This might be explained by the earlier described variations in measured thrust at a certain speed through water, as seen in Figure 8, due to for instance draft differences, seastate, wind and rudder actions, but also due to actual hull resistance variations. But when calculating the linear regression line over time through all the individual points, it is clearly visible that the hull resistance coefficient is increasing over time. The increase in hull resistance is +5.2% for the total measuring period. This equals to an increase of +3.6% per year.

4.3 Comparison ship performance evaluation via power versus thrust measurements

As shown in the previous paragraphs there are two ways used to measure the ship performance. The route via additional propeller thrust measurements allows for a split in performance between propeller and hull. But when adding both propeller and hull performance via the propeller thrust measurements, the outcome should be comparable to the total “ship resistance” measurement route via only torque measurements.

As the power (torque) is measured on board of the vessel via a different mechanism than the thrust is measured, both methods do have some independencies. Via the power measurements as described in paragraph 4.1, the total “ship resistance” increase, over the full measurement period, is +9.2%. When adding the propeller efficiency reduction of 3.7% to the hull resistance increase of +5.2%, as determined via the propeller thrust measurements in paragraph 4.2, the total “ship resistance” increase, over the full measurement period, is calculated to be +8.9%. Both measured total “ship resistance” increases are close to each other, supporting the accuracy of both measuring techniques used, and the accuracy of the individual measured propeller and hull performance.



5. CONCLUSIONS

In this paper two ways of measuring the ship propulsion performance are discussed. The first route is via measurement of the propeller power / torque. Via this route the total “ship resistance” change over time can be determined. For the +13000 TEU container vessel described in this paper, the measured total “ship resistance” increase over the measuring period of 1.5 years equals +9.2%. But via this way only the combined effect of propeller and hull can be measured.

As such a second route is discussed in this paper, which via additional propeller thrust measurements is able to split the propeller performance (efficiency) from the hull performance (resistance). For the +13000 TEU container vessel described in this paper, the measured propeller efficiency reduction over the measuring period of 1.5 years equals 3.7%. The separately measured hull resistance increase over the same measuring period equals to +5.2%. Both efficiency reductions combined, result in a total “ship resistance” increase of +8.9%. This figure is very much comparable with the total “ship resistance” increase as measured via the power / torque measuring route, providing an indication of the achieved accuracy of the individual measured propeller efficiency and hull resistance via the thrust measuring route.

The advantage of the thrust measuring route above the power / torque measuring route is, that via thrust measurements, the individual conditions of the propeller and hull can be quantified. Based on above presented measurements, the propeller plays an important role in the total propulsion performance decrease of the vessel. Based on this the proper decisions can be made for either only a propeller cleaning or repair, or only a hull cleaning. Next to this, the effects of for instance a propeller modification, or a new hull paint can be determined much more accurate. This at the end provides better input towards a proper investment decision for propulsion energy saving measures, or greenhouse gas reductions.

For this specific +13000 TEU container vessel the annual fuel consumption is approximately 30.000 metric tons. The measured decrease of propeller efficiency of 3.7% , and the measured increase in hull resistance of 5.2%, result both in additional fuel consumption and green house gas emissions. The additional fuel consumption means also an additional investment in fuel, which can be weighed against the needed investment for either a propeller or a hull cleaning.

A simple calculation with an assumed fuel oil price of US\$ 200,- per metric ton, indicates that the additional investments in fuel by respectively the propeller efficiency decrease, and the hull resistance increase, are:

	Efficiency decrease	Fuel increase mton / year	Fuel increase US\$ / year
Propeller efficiency decrease	3.7%	1110	222.000,-
Hull resistance increase	5.2%	1560	312.000,-

Based on the above outcome, only a propeller cleaning, at a lower investment cost compared to a total hull cleaning or even repaint, might be an interesting alternative, given the relative high fuel saving potential of the measured propeller efficiency decrease.

By using the TT-Sense® propeller thrust measuring possibilities the performance of the propeller and hull can be measured separately and therewith provide an important input to the **fuel saving and maintenance investment** decisions.

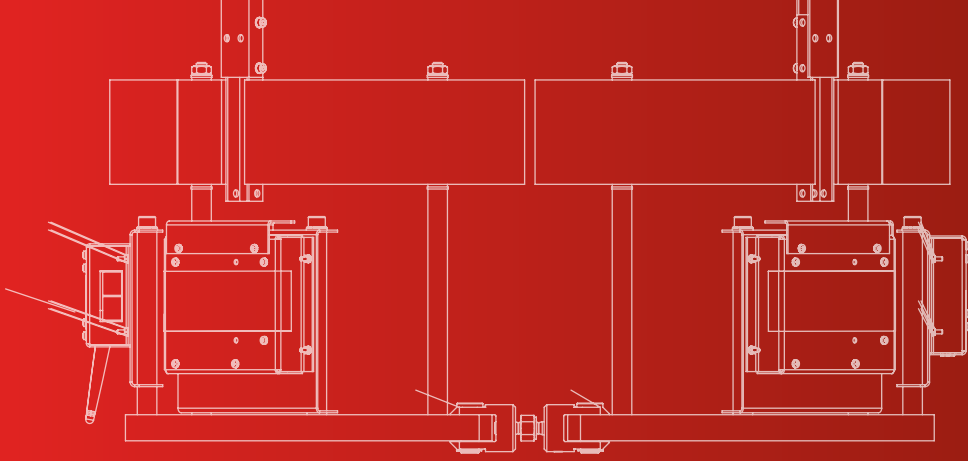

References

AAS-HANSEN, M. (2010), *Monitoring of hull conditions of ships*, MSc thesis Norwegian University of Science and Technology (NTNU) Trondheim, Norway

BOOM, van den, H.J.J.; HASSELAAR, T.W.F. (2014), *Ship Speed-Power Performance Assessment*, SNAME 2014 Annual Meeting

DINHAM-PEREN, T.A.; DAND I.W. (2010), *The need for full scale measurements*, William Froude Conference: Advances in Theoretical and Applied Hydrodynamics - Past And Future

LOGAN, K.P. (2011), *Using a Ship's Propeller for Hull Condition Monitoring*, ASNE Intelligent Ships Symposium IX - May 25, 2011, Philadelphia, PA, USA

MUNTEAN, T.V. (2011), *Propeller efficiency at full scale*, PhD thesis Technical University Eindhoven The Netherlands, ISBN 978-90-386-3072-4

SCHULTZ, M.P.; BENDICK, J.A.; HOLM, E.R.; HERTEL, W.M. (2011), *Economic impact of biofouling on a naval surface ship*, Biofouling Vol. 27, No. 1, January 2011, pp.87–98

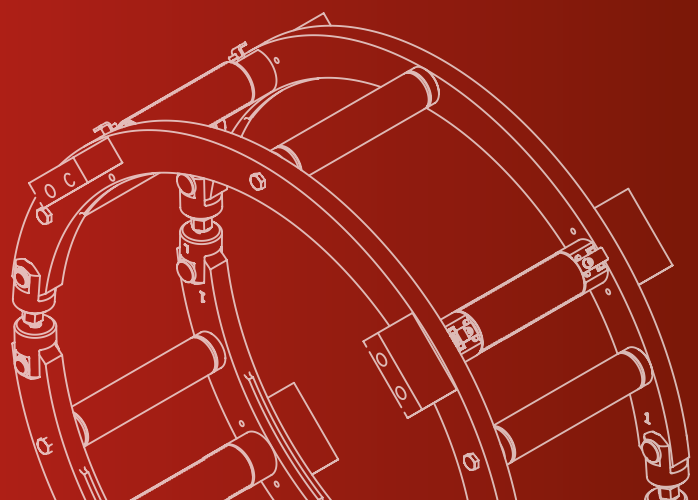

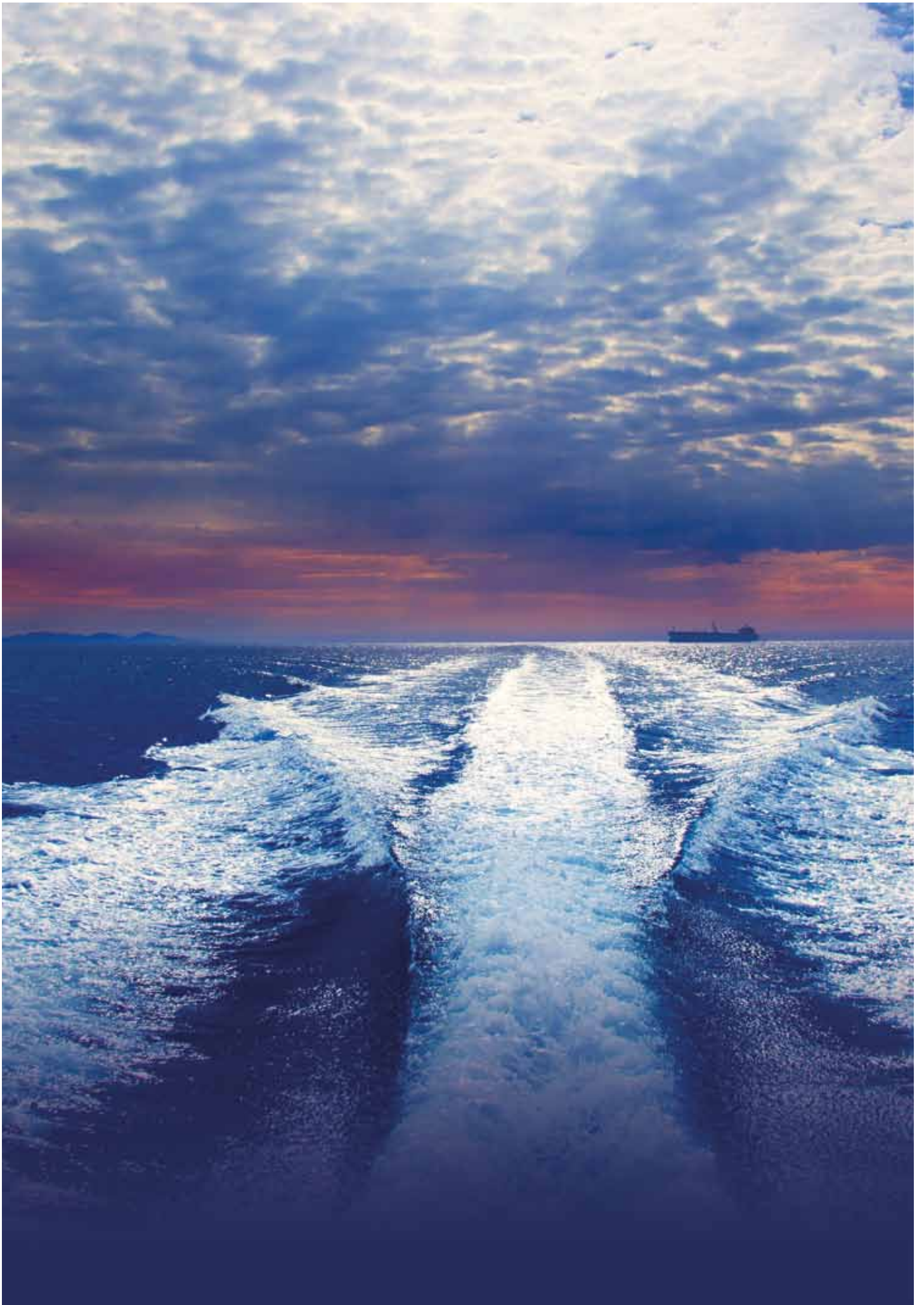

VAF

INSTRUMENTS

© VAF Instruments B.V. WP-2100-GB-0416

VAF Instruments B.V.
Vierlinghstraat 24, 3316 EL Dordrecht, The Netherlands
P.O. Box 40, 3300 AA Dordrecht, The Netherlands
T +31 (0) 78 618 3100, sales@vaf.nl

WWW.VAF.NL

**TO BE
REALLY
SURE**